

Multi Slice CT Phantom MHT

Elements such as high and low contrast resolutions, feed direction, and CTDI are enabled with this phantom for CT evaluations.



Features

MHT provides evaluation of physical properties of Multi Slice CT.

Non-aqueous/ Easy Set-up

KYOTOKAGAKU original human tissue substitute enables liquid-free evaluation session.

Axial/Volume Evaluation

The phantom is designed with enough length to allow evaluation in volume scanning.

① Low Contrast Phantom

Low contrast resolution evaluation in abdominal area

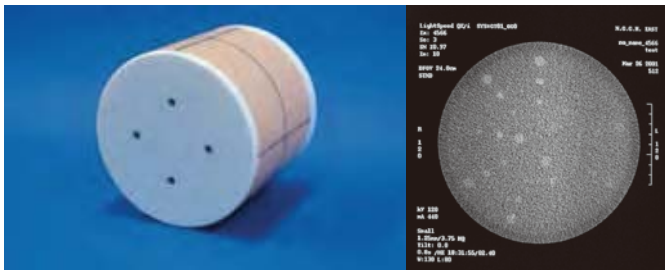

- Evaluation and comparison of low contrast resolution
- Evaluation of variation in contrast resolution in relation to bandwidth and the table speed.
- Evaluation of optimality of the sensitivity profile.
- Contrast-to-Noise Ratio (CNR) evaluation
- Sphere targets and cylinder targets with each three different densities are embedded in the back ground of human tissue substitute (HU50).
- Sphere targets are radially arranged forming a section parallel to the radiation beam.

Target sizes:
 diameter 3, 5, 7 and 10mm (sphere and cylinder)
 0.12, 0.2, 0.28 and 0.39 inch
 Target HU values: approx. 55, 60 and 65

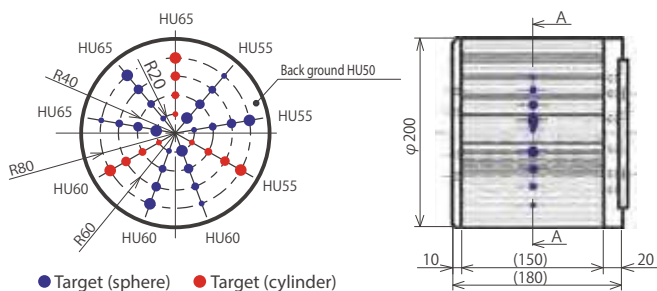

② High Contrast Phantom

High contrast resolution evaluation in lung area

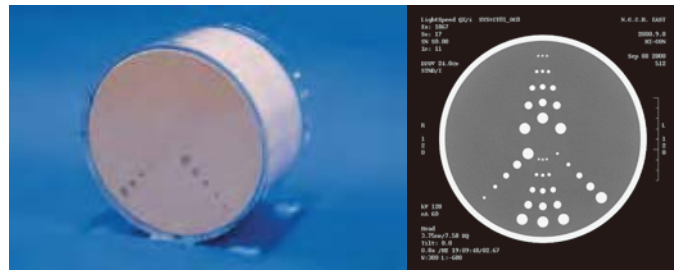

- Evaluation and comparison of high contrast resolution
- Evaluation of variation in contrast resolution in relation to bandwidth and the table speed.
- Evaluation of optimality of the sensitivity profile.
- Sphere targets and cylinder targets are embedded in the back ground of human lung substitute.
- Sphere targets are radially arranged forming a section parallel to the radiation beam.

Target sizes: diameter 2, 3, 5, 7 and 10mm (sphere and cylinder)
 0.08, 0.12, 0.2, 0.28 and 0.39 inch
 Target HU values: approx. 50

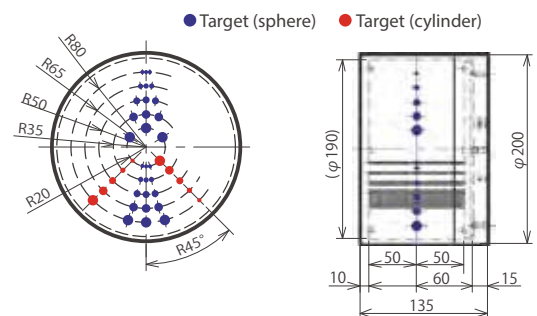

③ Elliptical Absorber

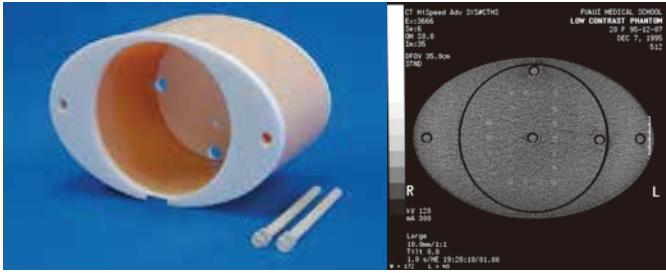

- Radiation absorber representing human torso to enable evaluation of beam hardening effect.
- The phantom is designed to accommodate Low Contrast Phantom, High Contrast Phantom or Low Contrast Phantom with CTDI.
- Two cylindrical chambers for dosimeters are made in the phantom.

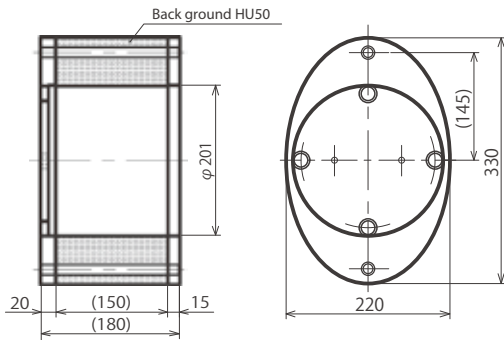

④ Low Contrast and CTDI Phantom



- Simultaneous evaluation of effective energy and low contrast resolution.
- Sphere targets and cylinder targets with each three different HU values are embedded in the back ground of human tissue substitute (HU50).
- Three cylindrical chambers for dosimeters are made in the phantom. Target HU values: approx. 55, 60 and 65

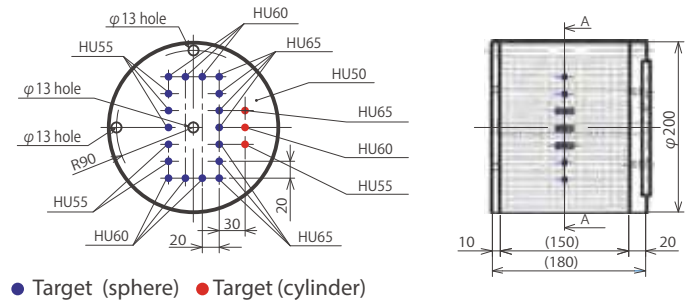

● Target (sphere) ● Target (cylinder)

⑤ Micro Disc Phantom SSPz evaluation in helical scanning

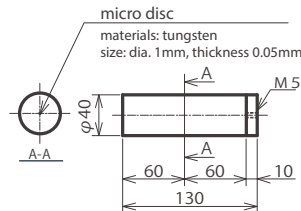

- Measurement and comparison of section sensitivity profile in z-axis.
- Evaluation of variation in contrast resolution in relation to bandwidth and the table speed.
- Measurement of effective slice thickness.

Angle Adjustment Holder



*specify the name of CT manufacturer at the time of your order.

Specifications

- ① Set Includes:
- ② Low Contrast Phantom
 - ③ High Contrast Phantom
 - ④ Elliptical Absorber
 - ⑤ Low Contrast Phantom with CTDI
 - Micro Disc Phantom
- Angle Adjustment Holder

Materials:
Urethane resin
acrylic resin
tungsten

Optional Parts:
PH-9-1 41334-110 Sliding Phantom Holder

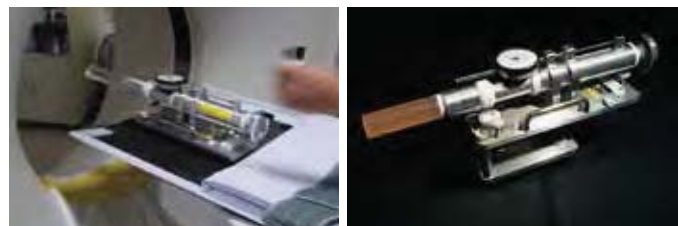

The holder allows sliding the micro disc phantom horizontally by 0.01mm.